

8.2 Applications of Quantum Mechanics

Lasers
Semiconductors
Semiconductor devices

Lasers

A laser is a light source that produces a focused, collimated, monochromatic beam of light.

The laser operates using the principle of stimulated emission of light.



Stimulated Absorption of light

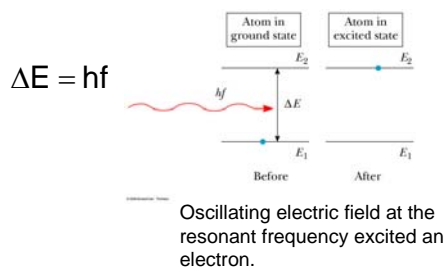

Spontaneous Emission of light

This is the normal process of emission e.g. in an atomic arc lamp.

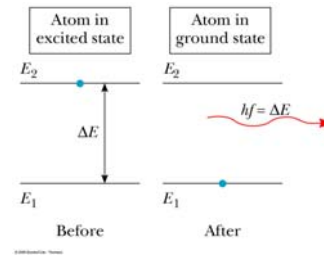

Stimulated Emission of light

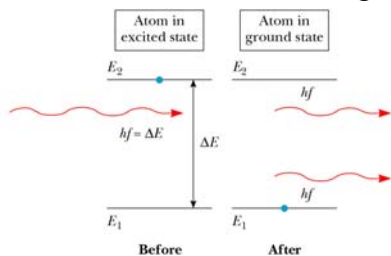

Similar to stimulated absorption except from the excited state.
The excess energy is emitted as a photon that is in phase with the incident photon.

Probabilities of simulated absorption and emission

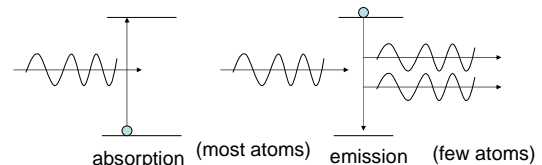

The probabilities for absorption and emission are the same.

Normally absorption dominates emission because most atoms are in the ground state.

Laser

Need to have more atoms in the excited state than in the ground state i.e.

Population Inversion

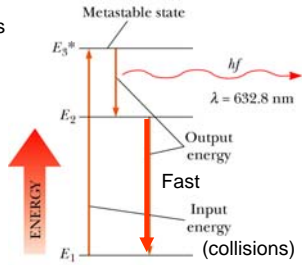

a scheme for producing a population inversion in He Ne laser

Laser cavity

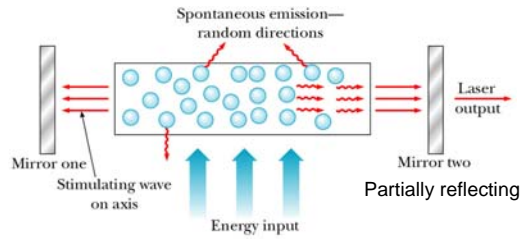

Stimulated Emission is enhanced along the direction of the reflected light giving a collimated light beam.

Lasers



ruby laser (1960)



Laser diode
Used in cd players etc.

Semiconductors

Semiconductors are materials such as silicon that in the crystalline state can be used to fabricate components such as diodes and transistors used in electronics devices such computers, cell phones, music players etc.

The key feature of semiconductors is the energy gap (Band Gap) between filled and vacant energy levels

Energy levels

Band Structure

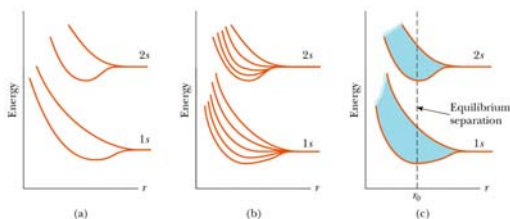

Two atoms

Five atoms

many atoms
(Crystal)

Energy levels in a crystal of a conductor (Na)

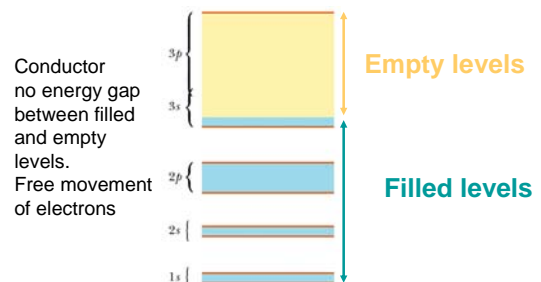

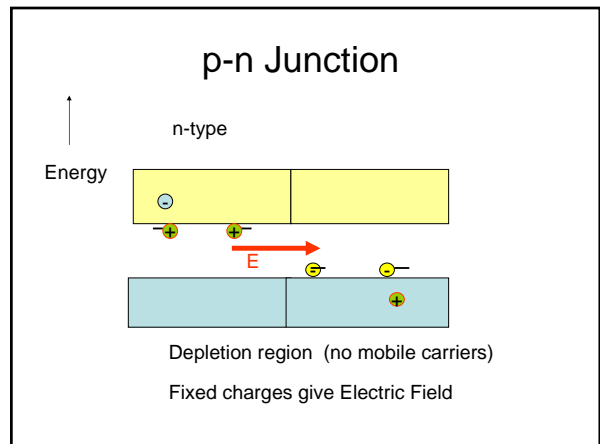
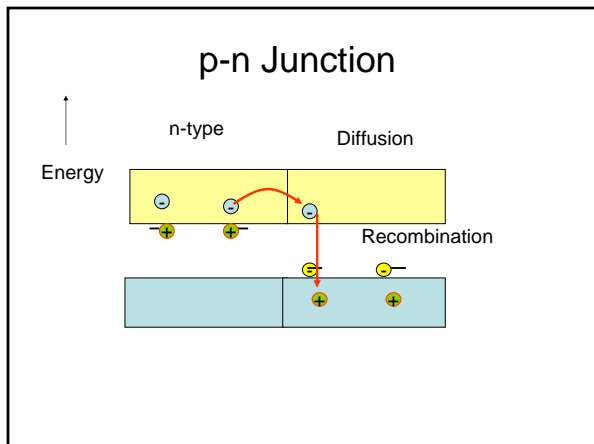
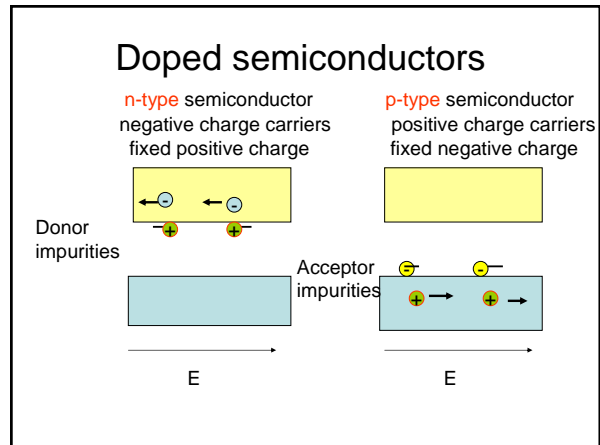
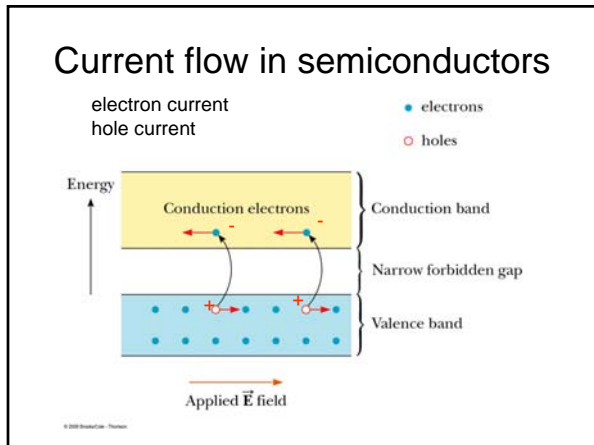
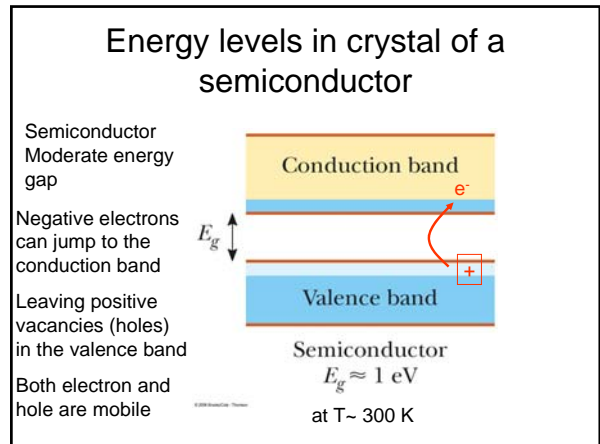
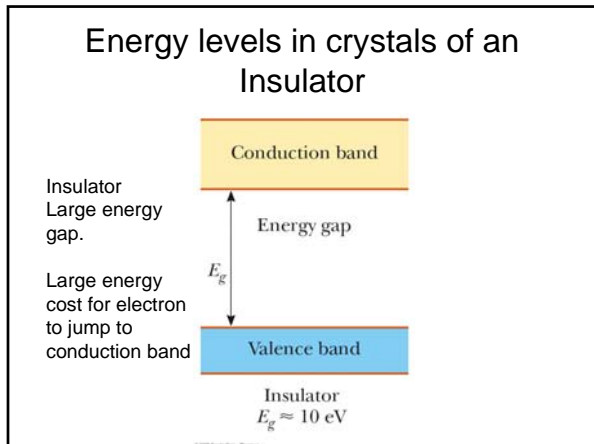

p-n Junction

Mobile charge carriers diffuse across the junction and create a depletion region of fixed charges.

At the interface a dipole is formed (+ - charges separate) creating an **electric field** and a **potential difference**.

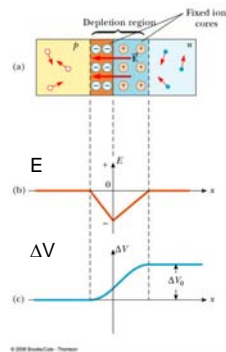

p-n junction

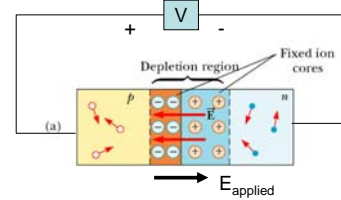

The depletion region is a barrier for current flow

An applied voltage that **opposes** the internal electric field reduces the size of the depletion region and current flows **Forward bias**

p-n junction

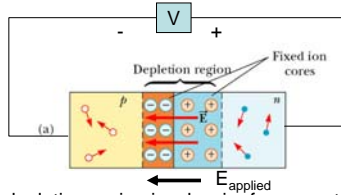

The depletion region is a barrier for current flow

An applied voltage that **increases** the internal electric field increases the size of the depletion region and no current flows. **Reverse bias**

p-n Junction diode

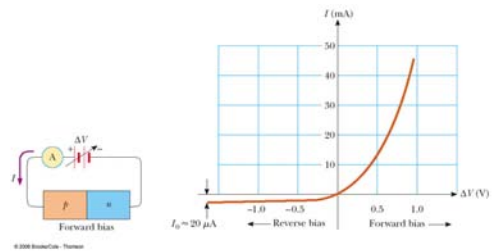

Current only flows in one direction.

p-n junctions

- Diodes
- Light emitting diodes
- Solar Cells
- Transistors

Diode

can be used as a rectifier.
converts alternating current into direct current

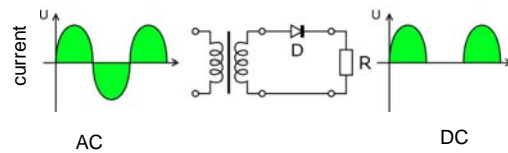

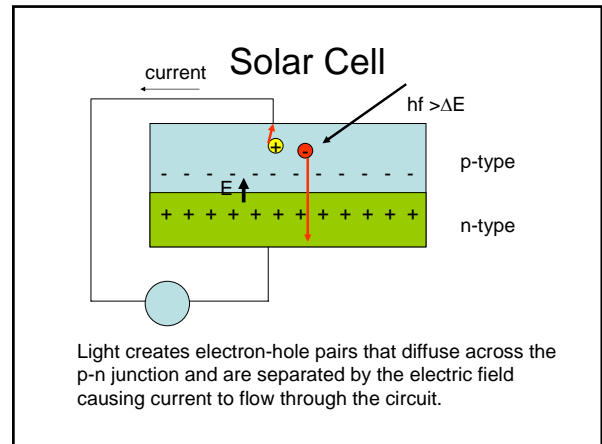
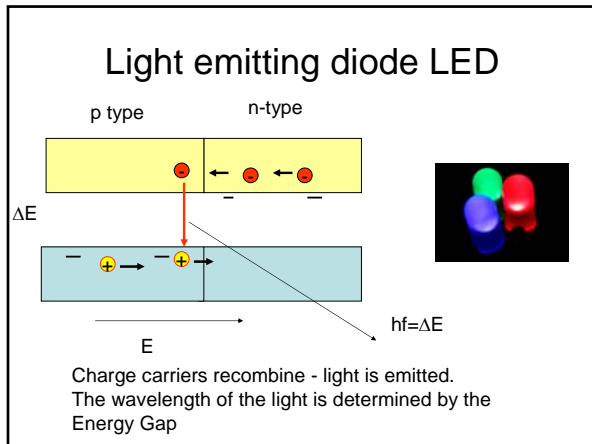

Solar cells

Solar energy

Sunlight is free but the cost of solar cells is high
Currently

- Single crystal silicon.
- Polycrystalline silicon

New Advances

- New semiconductor materials (CdTe, CuInSe₂)
- Thin films materials.

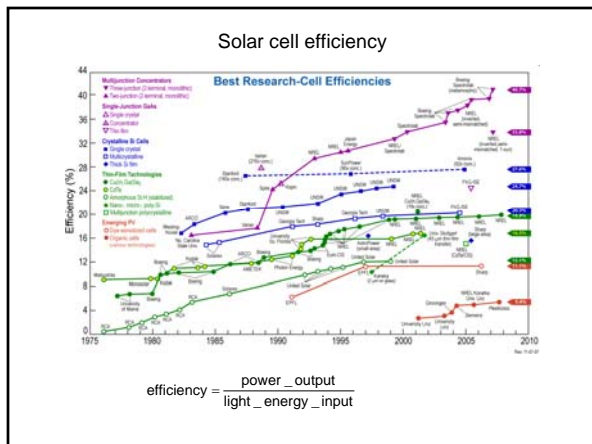
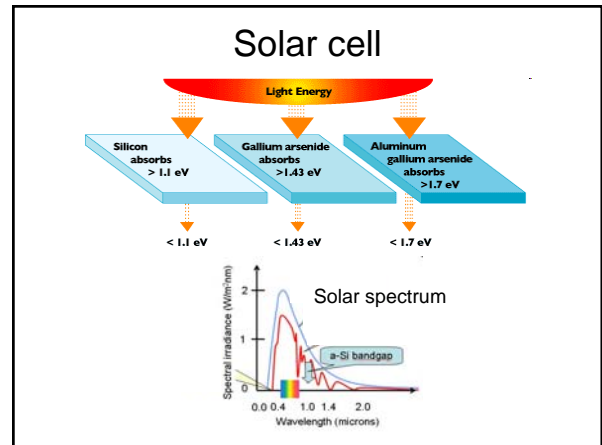

Party Balloon Solar Power System

www.renewableenergyworld.com/rea/news/article/2008/12/cool-earth-is-scaling-up-solar-energy-generation-54228

Cool Earth Solar, Livermore CA.

Advantage

- A cheap solar collector
- Uses smaller amount of silicon solar cell material.

Disadvantage

- Needs to be steered
- Shorter lifetimes.

Transistors

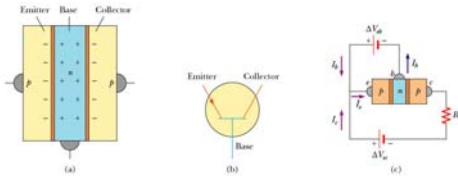

Transistor is a three input device.

A small current in one input (base) I_B changes the current flowing between the other two (emitter-collector) I_C giving rise to a **Current Gain** $\beta \sim 100$

$$I_C = \beta I_B$$

Current flow in a transistor

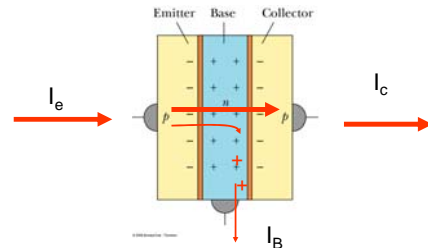

The base current I_B changes the charge in the base and electric field across the EB junction.

A small change in I_B produces a large change in I_C

Integrated circuits

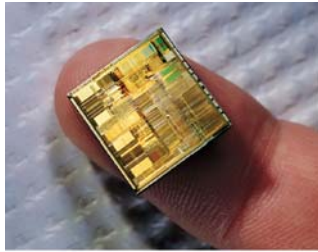

Many (10^7 - 10^9) of small components are fabricated onto semiconductor chips.